



United Pacific

TRUCK

2021 New Product Collection



HOW TO ORDER

To order from United Pacific Industries, you must be an authorized dealer, distributor or OEM.

If you are not authorized to stock and sell United Pacific products, you must order through an authorized dealer.

Please call 800.790.6988 for more information.

CONTACT US

 8 am - 4:30 pm PST

 Sales@upauto.com

 800.790.6988 / 562.421.3888

 UPauto.com

 888.986.5988

 3788 E. Conant St., Long Beach, CA 90808

QUALITY

With over 30 years of experience in the automotive aftermarket industry, United Pacific Industries understands the rigors and stresses that our products are subjected to on the road. It is our mission to provide our customers with products of superior quality and reliability. In achieving this goal, United Pacific only partners with manufacturing facilities that conforms to our quality control requirements and standards. Our manufacturing partners meet or exceed ISO-9001 requirements. In addition, United Pacific's manufacturing partners must be equipped on site to perform the following quality assurance tests and maintain a track record of consistent quality and low product failure rate.

- Photometric Test
- Pull Force Test
- Rain Test
- Salt Spray Test
- Shock Test
- Temperature Test
- Humidity Test
- Vibration Test

Furthermore, our internal quality control structure allows us to function as the final quality control station prior to shipping. With the assistance of 3D computer technology, United Pacific can adhere to strict quality control standards during prototype creation and the production process. Our engineers and technicians perform a battery of tests to ensure that our products meet the demands of today's drivers and our goal to be first in quality.

INNOVATION

Known as the leader in innovation, United Pacific is dedicated to be the first to bring new and exciting products to the market. United Pacific's global expertise allows us to search the globe for new ideas and concepts. Not only do we search the globe for new products, United Pacific invest a significant amount of resources into our own research and development efforts. With the assistance of advance 3D scanning technology, our engineers and designers can acquire accurate and precise data in seconds. The 3D data allows United Pacific to verify designs, perform quality assurance tests, and reverse engineer with unprecedented speed and accuracy. Digital inspection contributes to the early detection of shape problems, provides rapid feedback on design, and eliminates unnecessary work in downstream processes. Our rapid prototyping facility permits us to have a concept-to-shelf time of less than 5 months. In addition, United Pacific's 3D printing capabilities permit our designers to have physical models of their design concepts in hours. The physical models allow our designers and marketing staff to evaluate and test the viability of different design ideas. Our rapid prototyping facility allow United Pacific to compress design cycles, improve manufacturing planning, shorten concept-to-shelf time, most importantly, generate new and innovative products.

DESIGN

Located near some of the nation's most progressive automotive design centers, United Pacific established the UP Design Studio in 2002 to consolidate our position as the design leader in the automotive industry. UP Design Studio utilizes the latest generation of computer aided design (CAD) and studio/graphic software. The design studio is equipped with the newest computers and rapid prototyping systems. In addition, UP Design Studio is staffed by graduates from the nation's most prestigious design colleges. Unlike our competitors, United Pacific's design and manufacturing capabilities mean that we carry more new and original items than our competitors. The establishment of the design studio will enable us to generate even more new products with significant shorter concept-to-shelf time. The reduction in development cost mean that we can develop products utilizing design based development processes. Design based product development allows United Pacific to create new product concepts based on designs incorporating driver demands and needs instead of economic considerations. United Pacific's emphasis on design distinguishes and positions us ahead of our competitors.



WARRANTY

With LED (Light Emitting Diodes) rated at 100,000 hours of operation and solid-state construction, United Pacific's LED lights are extremely reliable and durable. Purchase with confidence, United Pacific offers a complete line of LED lighting products with extended or limited lifetime warranties. Please see the warranty policy page for more details.

INVENTORY AND SHIPPING

United Pacific carries over 20,000 items in our California distribution center. No other company in the heavy duty trucking industry can match United Pacific in the variety and range of in-stock inventories. With an order fill rate of over 98.5%, United Pacific is the largest and most reliable supplier in the industry. Our shipping department ships 96.8% of all orders within 24 hours and 98.9% within 48 hours. United Pacific's vast inventory and prompt shipping has made United Pacific the only source for our customer's chrome and lighting needs.



HARD AT WORK FOR THE ENVIRONMENT



United Pacific
132,000 sq ft

Distribution Center
Long Beach, CA

100%

reduction in potable water used for landscaping

40%

reduction in total energy use due to high-efficiency mechanical and lighting systems

82%

of construction waste was diverted from landfills

LEED ACCOMPLISHMENTS

Sustainable Sites

- On-site bicycle storage, showers and changing areas for company employees.
- Preferred parking for low-emitting, fuel-efficient and carpool vehicles.
- Storm water is infiltrated on-site and treated to remove contaminants to reduce environmental impact on local waterways.

Water Efficiency

- In addition to using reclaimed water, drought-tolerant plants and a high-efficiency irrigation system were installed to reduce the use of potable water for irrigation by 100%.

Energy and Atmosphere

- Efficient HVAC equipment and a lighting system with daylight controls reduces energy consumption by over 30%.
- Enhanced commission verifies that the building's energy and water-related systems are performing as intended by the initial design.

Indoor Environmental Quality

- Building ventilation systems was designed to provide enhanced levels of fresh outside air to building occupants.
- Interior finishes (plants, sealants, adhesives, coatings, carpet systems and composite wood) were selected with low levels of volatile organic compounds (VOCs) to reduce indoor air contamination.



NEW ITEMS

January 2021



42862



42861



Corner Bumper Cover For 2018-2021 Volvo VNL

- Quality injection molded plastic reproduction with original style semi-gloss black color
- Feature OE type mounting tabs and flange for easy installation to bumper corner
- Includes mounting bolts and washers
- Direct replacement to OEM number 82750588 (Driver) & 82750590 (Passenger)
- Sold individually, please specify driver or passenger side

42861 Driver - 1 Pc. / Box

42862 Passenger - 1 Pc. / Box

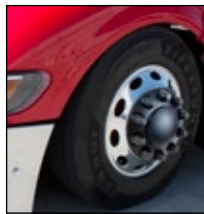

Matte Black Dome Axle Cover Combo Kit w/ 33mm Standard Nut Cover & Nut Cover Tool

- Matte black plastic dome axle cover combo kit
- Quality molded plastic with beautiful long lasting matte black finish
- Includes everything you need to dress up your wheels
- Kit includes: 2 black plastic dome front axle covers, 4 black plastic dome rear axle covers, 60 black plastic 33mm thread-on nut covers & 1 nut cover tool

10354 1 Set / Color Box



Matte Black Pointed Axle Cover Combo Kit w/ 33mm Spike Nut Cover & Nut Cover Tool

- Matte black plastic dome axle cover combo kit
- Quality molded plastic with beautiful long lasting matte black finish
- Includes everything you need to dress up your wheels
- Kit includes: 2 black plastic pointed front axle covers, 4 black plastic pointed rear axle covers, 60 black plastic 33mm spike thread-on nut covers & 1 nut cover tool

10355 1 Set / Color Box

NEW ITEMS

February 2021



Chrome LED Headlight for 2017-2021 International LT

- All LED headlight with white LED position light, amber LED turn signal, amber LED sidemarker light
- Beautiful chrome plated inner housing
- Patented headlight lens design with reflective turn signal diffusers for wider visibility, patent number D889,005
- Easy connection, plugs into existing wiring harness
- DOT/SAE, FMVSS 108
- Sold individually, please specify driver or passenger side

DOT

Technical Specification

Low Beam Application

3300 Lumens
3.5 Amps/12V

High Beam Application

1850 Lumens
2.15 Amps/12V

35757	Chrome	Driver - 1 Pc. / Color Box
35758	Chrome	Passenger - 1 Pc. / Color Box
35759	Blackout	Driver - 1 Pc. / Color Box
35760	Blackout	Passenger - 1 Pc. / Color Box



Headlight For 2003-2017 Volvo VN

- Beautiful chrome plated inner housing
- Unique aerodynamic lens design
- Turn signal: 3157 light bulb
- DOT/SAE, FMVSS 108
- Sold individually, please specify driver or passenger side

ExacFit
OE Style Headlight Assembly

DOT



Technical Specification

Low Beam Application

H11 Light Bulb
12V DC Input
4.38 Amps/55 Watt

High Beam Application

HB3 (9005) Light Bulb
12V DC Input
5 Amps/55 Watt

35901	Chrome	Driver - 1 Pc. / Box
35902	Chrome	Passenger - 1 Pc. / Box
35903	Blackout	Driver - 1 Pc. / Box
35904	Blackout	Passenger - 1 Pc. / Box



19 Amber LED Grakon 2000 Style Cab Light Kit

- Bright amber LED cab light with quality lens
- Polycarbonate lens sonically sealed to housing to prevent moisture intrusion
- Includes hardware and gasket, hard wired with two wires
- Fits Peterbilt 387, also fits various Peterbilt and Kenworth models
- Pre-assembled with beautiful chrome plated plastic cab light housing
- Cab light housing, can be purchase separately, item # 30674
- Available in amber or clear lens

30675 Amber LED/Amber Lens - 1 Pc. / Card

30676 Amber LED/Clear Lens - 1 Pc. / Card



LED Side Marker Light For 2018-2021 Volvo VNL

- Polycarbonate lens with fully sealed electronics
- Quality reproduction of original style lens and back housing
- Over molded mounting studs with original spec thread for easy installation, nut not included
- Direct plug-n-play with OEM style 2-pin Deutsch type connector
- Sold individually, please choose driver or passenger side

32825 Driver - 1 Pc. / Card

32826 Passenger - 1 Pc. / Card



Chrome Cab Light Housing - Grakon 2000 Style

- Beautiful high quality chrome plated finish with triple chrome plating process
- Includes hardware and gasket
- Fits Peterbilt 387, also fits various Peterbilt and Kenworth models

30674 1 Pc. / Card



Light & CB Antenna Bracket For 2018-2021 Freightliner Cascadia

- Stainless steel bracket for single stud pedestal light, and CB antenna
- Highly polished 304 stainless steel finish for durability and shine
- Mounts onto mirror arm. Simply remove two mirror arm mounting screws, install the bracket, and reinstall the longer screws included

42376 Driver - 1 Pc. / Box

42377 Passenger - 1 Pc. / Box



42858



42857

Bumper Corner Reinforcement With Front Cover For 2018-2021 Volvo VNL

- High quality plastic injection molded with OE spec detail and strengthening features
- Original style matte black front cover finish with heavy duty plastic inner reinforcement
- Include speed clips for easy and quick installation
- Suitable for models without fog lights
- Sold individually, please specify driver or passenger side
- Bumper end cover not included, available separately, item # 42861 (driver) 42862 (passenger)

42857 Driver - 1 Pc. / Box

42858 Passenger - 1 Pc. / Box



42860



42859

Bumper Corner Reinforcement With Front Cover & Fog Light Cutout For 2018-2021 Volvo VNL

- High quality plastic injection molded with OE spec detail and strengthening features
- Original style matte black front cover finish with heavy duty plastic inner reinforcement
- Include speed clips for easy and quick installation
- Precision cut fog light pocket for models with OE fog lights
- Sold individually, please specify driver or passenger side
- Bumper end cover not included, available separately, item # 42861 (driver) 42862 (passenger)

42859 Driver - 1 Pc. / Box

42860 Passenger - 1 Pc. / Box



Chrome Hood Mirror For Kenworth T680 & Peterbilt 579/587

- High quality mirror assembly with beautiful chrome plated mirror cover
- Complete hood mirror, includes mounting arm, backing plate and hardware
- Feature original style break-away internal mechanism
- Sold individually, please specify driver or passenger side

42838 Driver - 1 Pc. / Box

42839 Passenger - 1 Pc. / Box



Black Hood Mirror For Kenworth T680 & Peterbilt 579/587

- High quality mirror assembly with black mirror cover
- Complete hood mirror, includes mounting arm, backing plate and hardware
- Feature original style break-away internal mechanism
- Sold individually, please specify driver or passenger side

42840 Driver - 1 Pc. / Box

42841 Passenger - 1 Pc. / Box



Satin Black Grille Without Bug Screen For 2008-2016 Kenworth T660

- Quality injection molded plastic for durability
- Feature pocket and mounting hole for front hood emblem
- Include mounting speed clips for easy and quick installation
- Beautiful satin black painted finish

21056 1 Pc. / Box

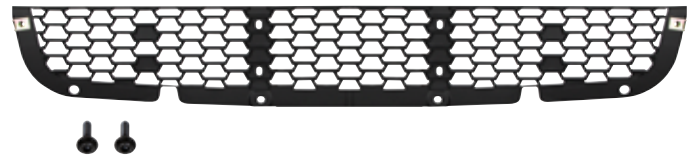

One Piece Bumper Mesh For 2018-2021 Freightliner Cascadia

- Original style bumper center mesh grille inserts for models with one-piece style bumper mesh
- Made of high quality injection molded plastic
- Laser scanned mounting holes from OE to ensure simple and quick replacement
- Not compatible for trucks with bumper mounted radar unit
- Include two pre-attached speed nuts with matching torx head screws

21951 1 Pc. / Box



42446



42448



Chrome Door Switch Cover With Power Windows For 2018-2021 Freightliner Cascadia

- Quality molded plastic with beautiful long lasting chrome plating
- Easy installation with double sided tape
- For door equipped with power windows

42446 Driver - 1 Pc. / Card

42488 Passenger - 1 Pc. / Card **NEW**



Chrome Long Dash Screw With Copper Diamond For Freightliner

- Chrome long dash screws with crystal diamond for Freightliner
- Beautiful high quality chrome plated finish with triple chrome plating process
- Fits various years and models
- Thread: #10 x 1-3/16" Long with 3/8" knurled head
- Available with copper color diamond

24051 2 Pcs. / Card

24051B 1 Pc. / Bulk



Signature Small Gauge Cover For 2006+ Peterbilt - Copper Diamond

- Signature chrome plastic gauge cover with crystal diamond for Peterbilt
- Beautiful high quality chrome plated finish with triple chrome plating process
- Small gauge application
- Fits 2006+ Peterbilt 379, 389, 388, 387, 386, and various other models
- US patent: D563, 815S, D579, 809S, additional patent pending
- Available with copper color diamond

40686 1 Pc. / Card



Rocker Switch Cover With 3 Openings & Copper Diamond For Freightliner (3 Pack)

- Chrome plastic rocker switch cover with three openings for Freightliner
- Beautiful high quality chrome plated finish with triple chrome plating process
- Fits Various Models
- Available with copper color diamond

42040 3 Pcs. / Card



Clock Bezel With Visor For Freightliner Century, Coronado & Columbia - Copper Diamond

- Quality injection molded plastic bezel with crystal diamond
- Beautiful high quality chrome plated finish with triple chrome plating process
- Fits 2-7/16" Diameter clock
- Feature a visor style design

41924 1 Pc. / Card



Short Dash Screw With Copper Diamond For Navistar International

- Chrome short dash screws with crystal diamond for International
- Beautiful high quality chrome plated finish with triple chrome plating process
- Fits various years and models

23872 6 Pcs. / Card

23872B 1 Pc. / Bulk

NEW ITEMS

March 2021

HIGH POWER LED HEADLIGHT FOR 2013-2017 VOLVO VN/VNL

COMPETITION SERIES

Our Competition Series headlights are the perfect solution for those looking to upgrade to United Pacific's superior quality with value and affordability in mind. The lights are feature-packed with OE-like build construction, enhanced projection beam patterns, and simple plug-and-play installation. The Competition Series are sure to light up the road for better safety and visibility for the everyday hardworking truck driver.



- All LED 12-24 volt headlight assembly for Volvo VN/VNL trucks
- 18 LED amber turn signal with sequential operation
- 100 LED white halo position lights
- 6 LED amber sidemarker light with P2 rating
- Easy connection, plug & play design, plugs into existing headlight wiring harness
- Trucks originally equipped with halogen lights may require LCM reflash for proper operation
- DOT/SAE, FMVSS 108
- Sold individually, please specify driver or passenger side

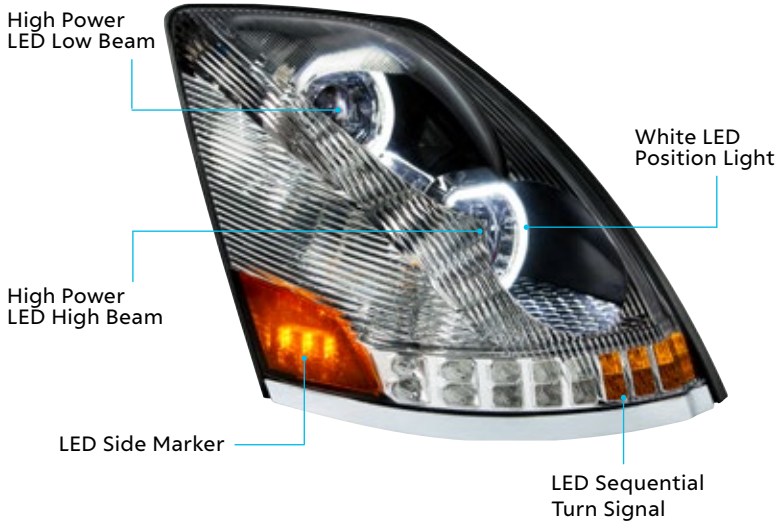

High Beam
3700
Lumens

Low Beam
2100
Lumens

100%
LED Lights

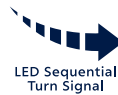

Technical Specification

Low Beam Application
2100 Lumens
1.2 Amps @ 12VDC
0.6 Amps @ 24VDC

High Beam Application
3700 Lumens
2 Amps @ 12VDC
1 Amps @ 24VDC

35749	Chrome	Driver - 1 Pc. / Color Box
35750	Chrome	Passenger - 1 Pc. / Color Box
35751	Blackout	Driver - 1 Pc. / Color Box
35752	Blackout	Passenger - 1 Pc. / Color Box



12 Amber LED Fender Turn Signal Light For 2014-19 Peterbilt 579 & 2011-19 587

- Unique lens and light bar with patent pending design
- Direct plug-n-play with OEM style connector
- Lifetime warranty
- Sold individually, please specify driver or passenger side, amber or clear lens

36395	Amber Lens	Driver - 1 Pc. / Card
36396	Amber Lens	Passenger - 1 Pc. / Card
36397	Clear Lens	Driver - 1 Pc. / Card
36398	Clear Lens	Passenger - 1 Pc. / Card



Chrome Hood Mirror For Kenworth T680

- High quality mirror assembly with beautiful chrome plated mirror cover
- Complete hood mirror, includes mounting arm, backing plate and hardware

42842	Driver - 1 Pc. / Box
42843	Passenger - 1 Pc. / Box

NEW



Aero Full-Moon Rear Axle Cover Kit

- Full disc wheel cover reduces aerodynamic drag and has a streamlined look
- Easy to remove and replace for wheel inspection and access tire valve stem pressure checks
- Fits standard 22.5" X 8.25" steel wheels and aluminum wheels
- Heavy duty plastic inner mounting base with easy snap-on plastic aero cover
- Includes thread-on nut covers, wheel protector film, and top cover removal tool
- Warning: Requires a minimum of 6 threads or half inch of threads extending through the top of each lug nut for proper installation
- Recommended nut cover installation tool pn. 10259 sold separately
- No warranty for damage caused by road debris, rocks, chemicals, truck washes, improper installation, etc.



10344	Black - 1 Pc. / Color Box	NEW
10326	Chrome - 1 Pc. / Color Box	



x5



ExacFit
OE Style Bumper

Center Bumper Inner Reinforcement For 2008-2017 Freightliner Cascadia Without OEM Radar (Box Of 5)

- High quality plastic injection molded with OE spec detail and strengthening features
- Aligns perfectly, interchangeable with OE
- OE style retaining tabs and clip-on speed nuts for securing bumper center
- Pocket for mounting and alignment of bumper end reinforcement
- For models without OEM Radar application only
- OEM #21-28443-010
- Shipped in box of 5, nested

20842M5 5 Pcs. / Box



x5

ExacFit
OE Style Bumper

Bumper End Without Fog Light Hole For 2008-2017 Freightliner Cascadia -Driver (Box Of 5)

- Original style reproduction without fog light hole
- Precision punched mounting holes for inner reinforcement
- OEM number: 21-27300-000, 21-27300-008
- Inner reinforcement available separately, item #20893
- Shipped in box of 5, nested

20846M5 5 Pcs. / Box



Blue Tiger Elite Ultra Bluetooth Headset - Black

- Made for hard working Trucker's, offering battery life for longest talk time, best comfort, and premium sound
- 60 hours battery life, 1200 hours of standby time
- Top noise-canceling technology means you hear every word and sound with amazing clarity
- Bluetooth 5.0 allows longer range, faster transfer speed for quicker connection between two devices
- Connect to Siri and Google Assistant
- Supports English, French and Spanish speakers
- Includes micro USB charging cable, DC adapter, extra mic cover, and quick start guide

95003 1 Pcs. / Color Box



7 LED 4" Stop, Turn & Tail - Red LED/Red Lens

- 7 LED 4" Round S/T/T Light
- Polycarbonate lens sonically sealed to housing to prevent moisture intrusion
- 12V DC, with 3 contact female terminal
- Recommend use with plug, item #34212, 34216 (not included)

39652B 1 Pcs. / Bulk

NEW ITEMS

April 2021



20 PCS. CONVENIENCE PACK

33mm X 2-3/4" Chrome Plastic Nut Covers W/ Flange - Push-On -Blue Reflector (20 Pack)

- Beautiful high quality chrome plated finish with triple chrome plating process
- Fits over standard 33mm lug nuts on hub piloted wheels
- Designed to cover up and hide the lug nut flange washer
- Convenience pack, includes 20 nut covers to dress up two wheels

10073 20 Pcs. / Color Box



Rocker Switch Trim For Peterbilt/ Kenworth With Copper Diamond (Card of 3)

- Beautiful high quality chrome plated finish with triple chrome plating process
- Fits various years of Peterbilt 378, 379, 386, 388, 389 and Kenworth T600, T660, T80, W900
- US patent: D587,660

41141 3 Pcs. / Card

Featured Items



Bluetooth Headsets for Trucker

- Top noise-canceling technology means you hear every word and sound with amazing clarity
- Bluetooth 5.0 allows longer range, faster transfer speed for quicker connection between two devices

95003 Blue Tiger Elite Ultra - 1 Pc. / Color Box

95002 Stellar Pluto + Duo - 1 Pc. / Color Box

NEW ITEMS

May 2021

Aero Full-Moon Rear Axle Cover Kit

Four Brand-new Finishes

Improve your truck's aerodynamics and reduce drag with our Aero Full-Moon Rear Axle Cover Kit. Easy snap-on installation takes almost no time at all. Have your rig standing out among the crowd with a streamlined look.



Reduces Aerodynamic Drag



Easy Snap-on Installation



Sleek & Streamline Design



10345 / Blue



10346 / Red



10326 / Chrome



10344 / Black

Features

- Full disc wheel cover reduces aerodynamic drag and has a streamlined look
- Easy to remove and replace for wheel inspection and access tire valve stem pressure checks
- Fits standard 22.5" X 8.25" steel wheels and aluminum wheels
- Heavy duty plastic inner mounting base with easy snap-on plastic aero cover
- Includes thread-on nut covers, wheel protector film, and top cover removal tool
- Warning: Requires a minimum of 6 threads or half inch of threads extending through the top of each lug nut for proper installation
- Recommended nut cover installation tool PN. 10259 sold separately
- No warranty for damage caused by road debris, rocks, chemicals, truck washes, improper installation, etc.

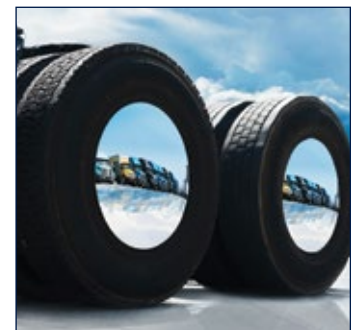

10345 Blue - 1 Pc. / Color Box **NEW**

10346 Red - 1 Pc. / Color Box **NEW**

10326 Chrome - 1 Pc. / Color Box

10344 Black - 1 Pc. / Color Box



Chrome Long Horn Bull Ornament

- Beautiful chrome plated finish with triple chrome plating process
- Exceptional details and sturdy cast metal construction
- Universal two stud installation, installs anywhere
- Approximately 7-1/2" x 8" x 4-1/4"
- Perfect as hood ornament, or as decoration for small and personal space, home, office and garage
- Mounting pad and hardware included



72034 1 Pc. / Color Box

60 PCS. CONVENIENCE PACK



33mm X 2 7/16" Chrome Plastic Standard Nut Cover W/ Flange - Push-On (Color Box of 60)

- Beautiful high quality chrome plated finish with triple chrome plating process
- Fits over standard 33mm lug nuts on hub piloted wheels
- Designed to cover up and hide the lug nut
- Convenience pack, includes 60 nut covers to dress up your entire truck

10058CB 60 Pcs. / Color Box

20 PCS. CONVENIENCE PACK



33mm X 2 3/8" Chrome Plastic Bullet Nut Covers W/ Flange - Push-On (Color Box Of 20)

- Chrome plastic bullet push-on nut cover for hex nuts and bolts
- Beautiful high quality chrome plated finish with triple chrome plating process
- Fits over standard 33mm lug nuts on hub piloted wheels
- Designed to cover up and hide the lug nut flange washer
- Convenience pack, includes 20 nut covers to dress up two wheels

10075 20 Pcs. / Color Box

10 PCS. CONVENIENCE PACK



33mm X 3 1/8" Chrome Plastic Spike Push-On Nut Covers - Color Box Of 10

- High quality chrome finish for durability and shine
- Fits over standard 33mm lug nuts on hub piloted wheels
- Designed to cover up and hide the lug nut flange washer
- Convenience pack, includes 10 nut covers to dress up one wheels

10769 10 Pcs. / Color Box

32 PCS. CONVENIENCE PACK



Chrome Spike Hubcap Nut Cover For 1999-2018 Chevy & GMC Full Size Truck - Push-on (Color Box of 32)

- Quality molded plastic with beautiful long lasting chrome plating
- Sized to fit the twist-on simulated lug nut on OE steel wheel hubcap
- Fits GM lug nut #9597158, M27-2.0, Hex 22mm
- Fits various 1999-2018 Chevy/GMC trucks
- Convenience pack, includes 32 nut covers to dress up your entire truck

10351CB 32 Pcs. / Color Box

32 PCS. CONVENIENCE PACK



Chrome Cylinder Hubcap Nut Cover For 1999-2018 Chevy & GMC Full Size Truck - Push-on (Color Box of 32)

- Quality molded plastic with beautiful long lasting chrome plating
- Sized to fit the twist-on simulated lug nut on OE steel wheel hubcap
- Fits GM lug nut #9597158, M27-2.0, Hex 22mm
- Fits various 1999-2018 Chevy/GMC trucks
- Convenience pack, includes 32 nut covers to dress up your entire truck

10749CB 32 Pcs. / Color Box



ExacFit
OE Style Bumper

5-Piece Bumper Kit For 2018-2021 Freightliner Cascadia

- High quality plastic injection molded with OE spec detail and strengthening features
- Bumper covers and inner reinforcements ship pre-assembled from factory
- Heavy duty steel mounting plates for direct bolt-on installation to truck frame
- Include black center bumper trim, 2-piece style center mesh screens, and mesh screen mounting brackets
- Additional fasteners included for connecting the 2 sides and bumper trim together
- Does not have air flow deflector mounting holes
- Available with or without fog light mounting pocket

21952 Without Fog Light - 1 Set / Box

21953 With Fog Light - 1 Set / Box



ExacFit

OE Style Headlight Assembly

Headlight Assembly For 2006-2014 Hino Medium Duty Truck

- Quality reproduction of the original headlight
- Fits Hino 2006-2010 165/185, 2006-2020 238/258/268/338
- Aftermarket replacement for OEM # 81150-E0530/81110-E0530
- Sold individually, please specify driver or passenger side

35723 Driver - 1 Pc. / Box

35724 Passenger - 1 Pc. / Box

NEW PACKAGING



DOT

IP67
WATER RESISTANT



1 3/4"



5 LED Reflector Clearance/Marker Light With Side Ditch light

- Clearance/marker light with 3 amber LED's, and 2 LED white side lights
- Down firing side LED ditch lights create better visibility and safety at night
- High quality chrome bezel for durability and shine
- 12 volt 2-wire hookup; 40 lumens
- SAE/DOT P2 and IP67 water resistant

39311 Amber LED / Clear Lens - 1 Pc. / Card

39312 Red LED / Clear Lens - 1 Pc. / Card



ExacFit

OE Style A/C Vent

Chrome A/C Vent For 2018-2021 Freightliner Cascadia

- Beautiful high quality chrome plated finish with triple chrome plating process
- Precision engineered adjustable louvers
- Easy installation, snaps in place of original vent
- Aftermarket replacement for OEM # 22-73856-001

42436 1 Pc. / Card

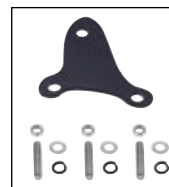

Die-Cast Fighting Stallion Hood Ornament

- Easy installation on any vehicle with three mounting studs
- Approximately 6-1/2" x 2-1/2" x 6-1/4"
- Mounting pad and hardware included
- Ideal for decorating small and personal space, home, office and garage

72018 Chrome - 1 Pc. / Color Box

72048 Matte Black - 1 Pc. / Color Box

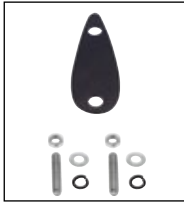

Die-Cast American Eagle Ornament

- Easy installation on any vehicle with two mounting studs
- Approximately 3-3/4" x 4-1/2" x 7-1/4"
- Mounting pad and hardware included
- Ideal for decorating small and personal space, home, office and garage

72007 Chrome - 1 Pc. / Color Box

72050 Matte Black - 1 Pc. / Color Box

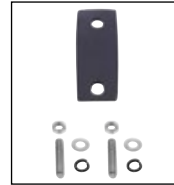

Die-Cast Bighorn Ornament

- Easy installation on any vehicle with two mounting studs
- Approximately 3-1/2" x 3-1/4" x 3-1/2"
- Mounting pad and hardware included
- Ideal for decorating small and personal space, home, office and garage

72051 Chrome - 1 Pc. / Color Box

72052 Matte Black - 1 Pc. / Color Box



United Pacific Cap - USA Flag United Pacific Cap

- 100% cotton twill cap
- Available in USA flag United Pacific Cap

99084 1 Pc. / Bulk

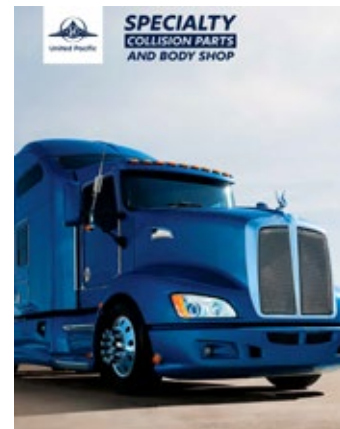

Truck Specialty Collision Parts Catalog 4th Edition

- High gloss, 4 color printed, perfect bound catalog.
- 104 pages + cover

UCSC4 1 Pc. / Bulk

NEW ITEMS

June 2021



9/10 Speed



Thread-On



Chrome Thread-On “Vegas” 9/10 Speed Gearshift Knob W/Adapter - Vertical

- Beautiful chrome plated finish with triple chrome plating process
- High quality, CNC machined
- Fits 9/10 speed with included adapter
- Removable thread locking sealant included

70786 1 Pc. / Color Box



13/15/18 Speed

New & Improved



Thread-On



Chrome Thread-On “Vegas” 13/15/18 Speed Gearshift Knob W/ Adapter - Vertical

- Beautiful chrome plated finish with triple chrome plating process
- High quality, CNC machined
- Fits 13/15/18 speed with included adapter
- Removable thread locking sealant included

70610 1 Pc. / Color Box

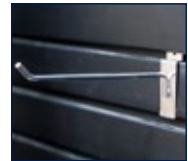

Chrome 8” Slatwall Hook

- Heavy duty steel with chrome plated finish
- Each hook can hold up to 20lbs maximum weight
- For use on slatwall panels

99173 1 Pc. / Bulk



13/15/18 Speed

New & Improved



Thread-On



Chrome Thread-On “Daytona” 13/15/18 Speed Spike Gearshift Knob W/Adapter - Vertical

- Beautiful chrome plated finish with triple chrome plating process
- High quality, CNC machined
- Fits 13/15/18 speed with included adapter
- Removable thread locking sealant included

70609 1 Pc. / Color Box

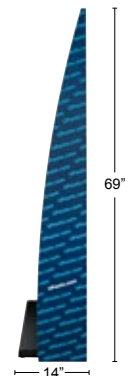
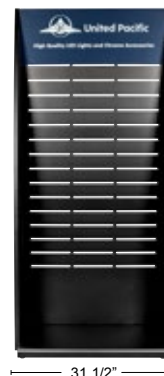

31 1/2"

14"

69"

United Pacific Store Slatwall Display

- Perfect way to display United Pacific products
- Size: 31.5” Wide x 14” Deep x 69” Tall
- Recommended display hooks: item# 99173

99142 1 Pc. / Box

NEW ITEMS

July 2021



36579



36580

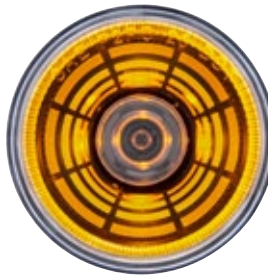

36581



36582

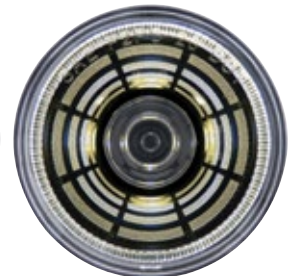

36583

4 LED 2-1/2" Abyss Clearance/Marker Light

- Features 4 bright LEDs with Abyss lens design gives unique infinity vision effect
- Polycarbonate lens sonically sealed to housing to prevent moisture intrusion
- Durable plastic housing with 2 contact female plug, works on all 12V DC system
- Recommend use with 2-pin male plug, item #34210, 34215 (not included)
- Mounts with standard 2-1/2" round rubber push-in grommet, item #31504, 31503 (not included)
- DOT/SAE P2, FMVSS 108
- Available in amber, red, or white LEDs with matching color lens or clear lens
- IP67 water resistant

World's First
Infinity Effect



Abyss Light™



36579	Amber LED/Amber Lens - 1 Pc. / Card
36580	Red LED/Red Lens - 1 Pc. / Card
36581	Amber LED/Clear Lens - 1 Pc. / Card
36582	Red LED/Clear Lens - 1 Pc. / Card
36583	White LED/Clear Lens - 1 Pc. / Card



36574



36575



36576

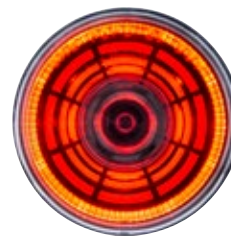

36577



36578

4 LED 2" Abyss Clearance/Marker Light

- Features 4 bright LEDs with Abyss lens design gives unique infinity vision effect
- Polycarbonate lens sonically sealed to housing to prevent moisture intrusion
- Durable plastic housing with 2 contact female plug, works on all 12V DC system
- Recommend use with 2-pin male plug, item #34210, 34215 (not included)
- Mounts with standard 2" round rubber push-in grommet, item #31505 (not included)
- DOT/SAE P2, FMVSS 108
- Available in amber, red, or white LEDs with matching color lens or clear lens
- IP67 water resistant

World's First
Infinity Effect



Abyss Light™



36574	Amber LED/Amber Lens - 1 Pc. / Card
36575	Red LED/Red Lens - 1 Pc. / Card
36576	Amber LED/Clear Lens - 1 Pc. / Card
36577	Red LED/Clear Lens - 1 Pc. / Card
36578	White LED/Clear Lens - 1 Pc. / Card



6 LED Clearance/Marker Light With 6 LED Side Ditch Light

- Quality clear polycarbonate lens with beautiful chrome inner housing
- Feature 6 bright SMD LEDs and 6 additional SMD LEDs as side ditch light
- Lens and back housing sonically sealed to prevent moisture intrusion
- For 12V DC system, 3 wire leads with .180" male bullet plugs
- Surface mount, 3-15/16" center-to-center mounting hole spacing
- DOT/SAE, P2 and IP67 water resistant
- Wiring color code: Black=Clearance/Marker light, Red=Ditch Light, White=Ground
- Recommended plug: item#34191, 34192
- Note: due to lens design, ditch light may show on side lens when clearance/marker is off
- Side ditch light available in white, amber, blue, or red LED color

Amber LED Marker Light

- 39298** Amber LED Marker/White LED Ditch Light - 1 Pc. / Card
- 39299** Amber LED Marker/Amber LED Ditch Light - 1 Pc. / Card
- 39300** Amber LED Marker/Blue LED Ditch Light - 1 Pc. / Card
- 39301** Amber LED Marker/Red LED Ditch Light - 1 Pc. / Card

Red LED Marker Light

- 39302** Red LED Marker/White LED Ditch Light - 1 Pc. / Card
- 39303** Red LED Marker/Amber LED Ditch Light - 1 Pc. / Card
- 39304** Red LED Marker/Blue LED Ditch Light - 1 Pc. / Card
- 39305** Red LED Marker/Red LED Ditch Light - 1 Pc. / Card

20 PCS. CONVENIENCE PACK



33mm X 2-7/16" Chrome Plastic Standard Nut Covers W/ Flange - Push-On (Color Box of 20)

- Beautiful high quality chrome plated finish with triple chrome plating process
- Fits over standard 33mm lug nuts on hub piloted wheels
- Designed to cover up and hide the lug nut flange washer
- Convenience pack, includes 20 nut covers to dress up two wheels

10058 20 Pcs. / Color Box

20 PCS. CONVENIENCE PACK



33mm X 2-3/4" Chrome Plastic Nut Covers W/ Flange - Push-On -Red Reflector (20 Pack)

- Beautiful high quality chrome plated finish with triple chrome plating process
- Fits over standard 33mm lug nuts on hub piloted wheels
- Designed to cover up and hide the lug nut flange washer
- Convenience pack, includes 20 nut covers to dress up two wheels

10071 20 Pcs. / Color Box

9/10 Speed

New & Improved



Chrome Thread-on “Daytona” 9/10 Speed Gearshift Knob With Adapter - Vertical

- Vertically mounted gearshift knob with CNC machined grip, and durable thread-on mount
- Fits 9/10 speed Eaton Fuller shifter
- Beautiful high quality chrome plated finish with triple chrome plating process
- Thread lock adhesive and instructions included

70784 1 Pc. / Color Box

9/10 Speed

New & Improved



Chrome Thread-on “Austin” 9/10 Speed Gearshift Knob With Adapter - Vertical

- Vertically mounted gearshift knob with CNC machined grip, and durable thread-on mount
- Fits 9/10 speed Eaton Fuller shifter
- Beautiful high quality chrome plated finish with triple chrome plating process
- Thread lock adhesive and instructions included

70785 1 Pc. / Color Box

13/15/18 Speed

New & Improved



Chrome “Austin” 13/15/18 Speed Gun Cylinder Gearshift Knob w/ Adapter - Vertical

- Chrome “Austin” gun cylinder gearshift knob, vertical mount
- Fits 13/18 speed gearshift knobs, CNC-machined grip
- Mounting adapter item # 70604b & “Austin” gun cylinder grip item # 70645b available separately
- *Patent pending*

70650 1 Pc. / Color Box



Black Heavy Duty Belt Strap Winder

- Clamps to trailer side rails conveniently
- Winds 2” to 4” straps smoothly

90108 1 Pc. / Box

NEW ITEMS

August 2021



36564



36565



36566

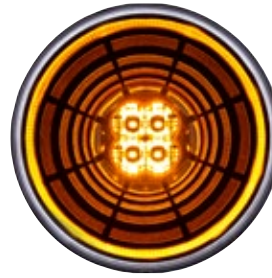

36567



36568

13 LED 4" Round Abyss Turn Signal Light

- Abyss lens design gives unique infinity vision effect
- Polycarbonate lens sonically sealed to housing to prevent moisture intrusion
- Electronics completely sealed in epoxy inside a corrosion and impact resistant housing
- Durable plastic housing with 3 contact female plug
- Works with any 12V DC system
- Uses 3-pin electrical connector plug, item #34212/34216
- Mounts with standard 4" round rubber push-in grommet, item #31515
- DOT/SAE, FMVSS 108. Lifetime warranty

World's First
Infinity Effect



Abyss Light™



36564	Red LED/Red Lens - 1 Pc. / Card
36565	Amber LED/Amber Lens - 1 Pc. / Card
36566	Red LED/Clear Lens - 1 Pc. / Card
36567	Amber LED/Clear Lens - 1 Pc. / Card
36568	White LED/Clear Lens - 1 Pc. / Card

10 PCS. CONVENIENCE PACK



1-1/8" x 2 13/16" Chrome Plastic Spike Nut Covers - Push-On (Color Box Of 10)

- Beautiful chrome plated finish with triple chrome plating process
- Designed to cover up and hide the lug nut flange washer
- Convenience pack, includes 10 nut covers to dress up one wheel

10771 10 Pcs. / Color Box

10 PCS. CONVENIENCE PACK



1-1/8" x 2 13/16" Chrome Plastic Spike Nut Covers - Push-On (Color Box Of 10)

- High quality injection molded plastic with beautiful triple chrome plated finish
- Designed to cover up and hide the lug nut
- Convenience pack, includes 10 nut covers to dress up one wheel

10768 10 Pcs. / Color Box



ExacFit
OE Style Dash Trim

Passenger Side Dash Trim For 2018+ Freightliner Cascadia

- Beautiful chrome plated finish with triple chrome plating process
- Smooth style without emblem holes, replaces trim piece directly under the passenger side vents
- Feature original style clip-on design for easy installation
- For easy removal, use of non-marking plastic pry tool is recommended, U.P. item#99135

42499 1 Pc. / Card



48007



48008



Stainless Steel Switch Plate For Peterbilt 359

- Highly polished stainless steel plate with laser etched scripts
- Easy installation with original mounting holes, mounting hardware included

48007 Air Suspension - 1 Pc. / Card

48008 Axle Differential - 1 Pc. / Card



Center Bumper Without Center Trim Mounting Holes For 2008-2017 Freightliner Cascadia (Box Of 5)

- Quality plastic injection molded with OE spec detail and strengthening features
- Aligns perfectly, interchangeable with OE
- Clips and mounting hardware are included
- Does not have cutouts and holes for center trim
- Dark gray color, like original
- OEM #21-28446-000
- Shipped in box of 5, nested

20845M5 5 Pcs. / Box



2020 New Product Collections

- High gloss, 4 color printed, perfect bound catalog.
- 48 pages + cover

UF1220 1 Pc. / Bulk

NEW ITEMS

September 2021



36569

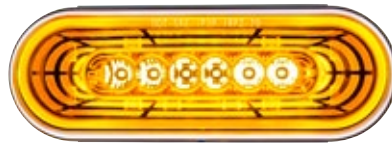

36570



36571

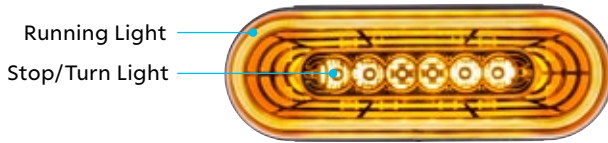

36572



36573

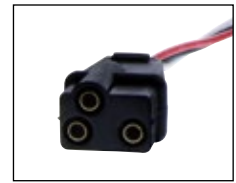

22 LED 6" Oval Abyss Light (Stop, Turn & Tail Light)

- Polycarbonate lens sonically sealed to housing to prevent moisture intrusion
- Epoxy coated, fully sealed electronics designed for 12V DC systems
- Abyss lens design gives unique infinity vision effect
- Corrosion and impact resistant plastic housing with 3 contact female plug
- Recommend using with 3-pin electrical plug, item #34212, 34216
- Recommend mounting with standard 6" oval rubber grommet, item #31506
- DOT/SAE, FMVSS 108

World's First
Infinity Effect



36569	Red LED/Red Lens - 1 Pc. / Card
36570	Amber LED/Amber Lens - 1 Pc. / Card
36571	Red LED/Clear Lens - 1 Pc. / Card
36572	Amber LED/Clear Lens - 1 Pc. / Card
36573	White LED/Clear Lens - 1 Pc. / Card



New & Improved



Thread-On

Chrome Skull Biker Thread-on Shift Knob

- High quality die-cast zinc with triple chrome plating
- Inside thread 1/2"-13
- Dress up your truck with show winning shine
- Designed to work best with UP shift knob adapter, #70589B (May also work with other adapters with 1/2"-13 thread)

70780B 1 Pc. / Bulk



New & Improved



Thread-On

13/15/18 Speed

Chrome Skull Biker 13/15/18 Speed Gearshift Knob With Adapter

- Ultra high quality chrome plated finish with triple chrome plating process
- Highly detailed aluminum skull with helmet and goggles
- Fits 13/15/18 speed gear shifter with included adapter

70642 1 Pc. / Card

COMPETITION SERIES



Chrome 10 LED Headlight for 2013-2021 Kenworth T680

- All LED 12-24 volt headlight assembly for Kenworth T680 trucks
- 9 LED amber turn signal with sequential operation
- 100 LED white halo position lights
- 6 LED amber side marker light with P2 rating
- Easy connection, plug & play design, plugs into existing headlight wiring harness
- Bold and unique headlight design, patent #D907,260
- DOT/SAE, FMVSS 108
- Sold individually, please specify driver or passenger side



35741	Chrome	Driver - 1 Pc. / Color Box
35742	Chrome	Passenger - 1 Pc. / Color Box
35743	Blackout	Driver - 1 Pc. / Color Box
35744	Blackout	Passenger - 1 Pc. / Color Box

Technical Specification

Low Beam Application
 2100 Lumens
 2.5 Amps @ 12VDC
 1.25 Amps @ 24VDC

High Beam Application
 3700 Lumens
 7.0 Amps @ 12VDC
 2.75 Amps @ 24VDC

NEW ITEMS

October 2021



10 LED Headlight For Peterbilt 587 (2010-2016) & 579 (2012-2021)

- All LED 12-24 volt headlight assembly for Peterbilt 579/587 trucks
- 9 LED amber turn signal with sequential operation
- 100 LED white halo position lights
- 9 LED amber side marker light with P2 rating
- Easy connection, plug & play design, plugs into existing headlight wiring harness
- Bold and unique headlight design, patent #D898,960
- Low beam: 2,100 Lumens, 1.2 Amps @ 12VDC, 0.6 Amps @ 24VDC
- High beam: 3,700 Lumens, 2 Amps @ 12VDC, 1 Amps @ 24VDC
- DOT/SAE, FMVSS 108

35745	Chrome	Driver - 1 Pc. / Color Box
35746	Chrome	Passenger - 1 Pc. / Color Box
35747	Blackout	Driver - 1 Pc. / Color Box
35748	Blackout	Passenger - 1 Pc. / Color Box



COMPETITION SERIES

Technical Specification	
Low Beam Application	High Beam Application
2100 Lumens	3700 Lumens
1.2 Amps @ 12VDC	2 Amps @ 12VDC
0.6 Amps @ 24VDC	1 Amps @ 24VDC

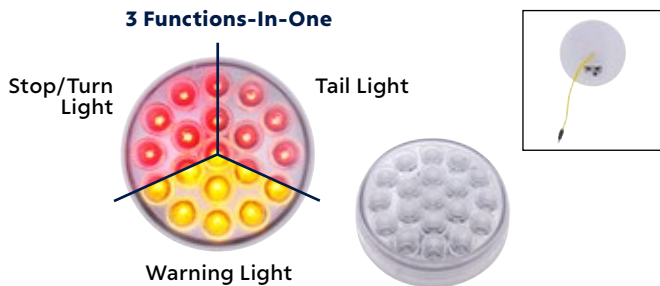

19 LED 4" Round Double Fury Stop, Turn, & Tail Light With Warning Light Function

- High quality injection molded polycarbonate lens
- Bright dual function red LEDs for stop, turn, and tail light
- Features warning light function with amber LEDs
- 2V DC, rear plastic housing with 3-pin female contact terminal
- Additional wire lead with male bullet plug for warning light function
- Recommend use with 3-pin male plug, item #34212, 34216 (not included)
- Recommend mount with rubber push-in grommet, item #31515 (not included)
- DOT/SAE, FMVSS 108
- IP67 water resistant



36722 1 Pc. / Card

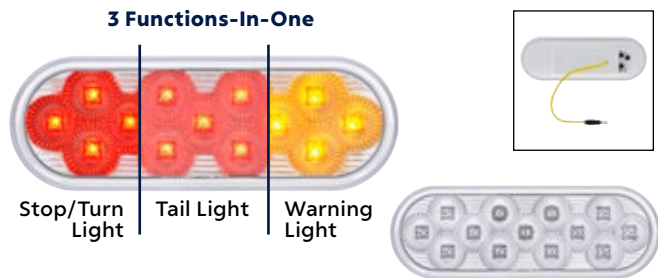

13 LED 6" Oval Double Fury Stop, Turn, & Tail Light With Warning Light Function

- High quality injection molded polycarbonate lens
- Bright dual function red LEDs for stop, turn, and tail light
- Features secondary warning light function with amber LEDs
- 12V DC, rear plastic housing with 3-pin female contact terminal
- Additional wire lead with male bullet plug for warning light function
- Recommend use with 3-pin male plug, item #34212, 34216 (not included)
- Recommend mount with rubber push-in grommet, item #31506 (not included)
- DOT/SAE, FMVSS 108
- IP67 water resistant



36723 1 Pc. / Card

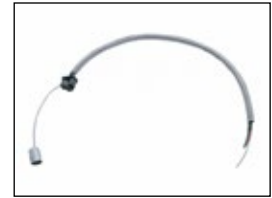

Stainless steel wire loom pre-wired internally



Guide 682-C Style Headlight Assembly With Crystal Lens & 34 LEDs Position Light (Horizontal Mount)

- Fully assembled with crystal halogen headlight bulb with amber LED side position lights
- Headlight features 34 amber LEDs with reinforced multi-faceted aluminum reflector housing
- Bright amber LEDs can be wired to use as turn signal light or parking light
- Include single 65/55W 12V H4/HB2/9003 halogen bulb
- Ships with stainless steel wire loom, lights pre-wired internally
- Horizontal mounting post design, for installing on any reinforced vertical surface
- DOT/SAE, FMVSS 108

32543	Stainless Steel Housing	Driver - 1 Pc. / Box
32544	Stainless Steel Housing	Passenger - 1 Pc. / Box
32842	Chrome Housing	Driver - 1 Pc. / Box
32843	Chrome Housing	Passenger - 1 Pc. / Box



Stainless steel wire loom pre-wired internally

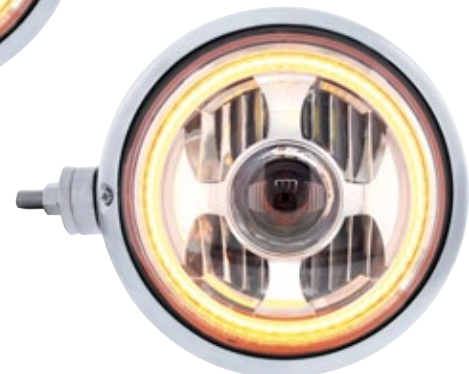

Guide 682-C Style Headlight Assembly With LED Headlight & Dual Color Position Light (Horizontal Mount)

- Fully assembled with super bright LED projector headlight with dual color LED position light
- LED headlight with 1,200 lumens on low beam, 2,700 lumens on high beam
- Dual color white/amber LED position light with amber automatic override feature
- Water resistance headlight with IP67 rating, diecast housing and polycarbonate lens
- Ships with stainless steel wire loom, lights pre-wired internally
- Horizontal mounting post design, for installing on any reinforced vertical surface
- DOT/SAE, FMVSS 108

32844	Stainless Steel Housing	Driver - 1 Pc. / Box
32845	Stainless Steel Housing	Passenger - 1 Pc. / Box
32846	Chrome Housing	Driver - 1 Pc. / Box
32847	Chrome Housing	Passenger - 1 Pc. / Box



Stainless steel wire loom
pre-wired internally



Guide 682-C Style Headlight Assembly With Crystal Lens & 10 LEDs Position Light (Horizontal Mount)

- Fully assembled with crystal halogen headlight bulb with amber LED bottom position lights
- Headlight features 10 amber LEDs with reinforced multi-faceted aluminum reflector housing
- Bright amber LEDs can be wired to use as additional turn signal light or parking light
- Include single 65/55W 12V H4/HB2/9003 halogen bulb
- Ships with stainless steel wire loom, lights pre-wired internally
- Horizontal mounting post design, for installing on any reinforced vertical surface
- DOT/SAE, FMVSS 108

32848	Stainless Steel Housing	Driver - 1 Pc. / Box
32849	Stainless Steel Housing	Passenger - 1 Pc. / Box
32850	Chrome Housing	Driver - 1 Pc. / Box
32851	Chrome Housing	Passenger - 1 Pc. / Box



430 SS Bug Deflector With Hood Tilt Handle For 2018-2021 Freightliner Cascadia

- Highly polished 430 stainless steel
- Includes sturdy built-in grab handle for hood tilt
- Requires drilling holes for installation
- Hardware included for installation

29150 1 Pc. / Box



430 SS Sunvisor For 2014-2021 Freightliner Cascadia With Raised/Mid-Roof

- Highly polished 430 stainless steel
- Sunvisor includes cutouts for OEM lights
- Requires drilling holes in roof to install
- Hardware included for installation
- Not compatible with DayCab models

29151 1 Pc. / Box



ABS Tow Hook Cover For 2018-2021 Volvo VNL

- Quality injection molded ABS plastic
- Black painted finish
- Easy installation with OE style mounting tabs and posts

42502 **Driver** - 1 Pc. / Box

42503 **Passenger** - 1 Pc. / Box



ABS Bumper Corner Trim With Fog Light Opening For 2018-2021 Volvo VNL

- Quality injection molded ABS plastic
- Satin silver painted finish
- Easy installation with pre-applied double sided tape
- For use on truck with original fog lights

42504 **Driver** - 1 Pc. / Box

42505 **Passenger** - 1 Pc. / Box



Blue Tiger Elite Ultra Bluetooth Headset - US Flag

- Top noise-canceling technology allows you to hear every word and sound with amazing clarity
- Bluetooth 5.0 allows longer range, faster transfer speed for quicker connection between two devices
- Latest edition with US flag graphic
- Made for hard working Truckers, offering battery life for longest talk time, best comfort, and premium sound
- Connect to Siri and Google Assistant
- 60 hours battery life (talk time), 1200 hours of standby time
- Supports English, French and Spanish speakers
- Includes micro-USB charging cable, DC adapter, extra microphone cover, and quick start guide

95004 1 Pc. / Color Box





Header Sign Bracket
Available Separately,
Item # 99030

46" X 7" Freightliner Header Sign

- United Pacific header/fixture sign with Freightliner name brand header
- Perfect for product identification

99034 1 Pc. / Box



Header Sign Bracket
Available Separately,
Item # 99030

46" X 7" LED Header Sign

- United Pacific header/fixture sign with LED header
- Perfect for product identification

99036 1 Pc. / Box



48" X 36" United Pacific Truck Products Banner

- Banner for United Pacific truck parts and accessories
- Dimension approximately 48" wide X 36" length

99100 1 Pc. / Box

NEW ITEMS

November 2021



LED Headlight For 2001-2020 Freightliner Columbia

- All LED headlight with high power 15W LED low beam and high beam
- 12 amber LED turn signal light and 2 LED parking light
- Beautiful chrome plated inner housing
- Easy connection, plugs into existing wiring harness
- Low beam: 1650 Lumens, 1.3 Amps, 12V DC Input
- High beam: 1650 Lumens, 1.3 Amps, 12V DC Input
- DOT/SAE, FMVSS 108

35845	Chrome	Driver - 1 Pc. / Box
35846	Chrome	Passenger - 1 Pc. / Box
35851	Blackout	Driver - 1 Pc. / Box
35852	Blackout	Passenger - 1 Pc. / Box

DOT & SAE **100%LED**

Technical Specification

Low Beam Application

1650 Lumens
1.3 Amps @ 12VDC

High Beam Application

1650 Lumens
1.3 Amps @ 12VDC



10 High Power LED Projection Headlight Assembly With Mounting Arm

- All LED dual function headlight assembly with chrome plastic housing and die cast mounting arm
- Direct replacement for Peterbilt 379, other models such as 357/359/365/367/378/389/567 will require minimal modification to hood for mounting hole alignment
- Easy installation with OE spec threaded mounting holes
- Includes long wiring loom for electrical hookup
- Also great for any custom applications
- Low beam: 1,600 Lumens, 2.1 Amps
- High beam: 2,400 Lumens, 2.25 Amps
- 12V-24VDC, total power consumption 70 Watts / 6.35 amps @ 12VDC
- DOT/SAE, FMVSS 108

35775	Chrome	Driver - 1 Pc. / Color Box
35776	Chrome	Passenger - 1 Pc. / Color Box
35777	Blackout	Driver - 1 Pc. / Color Box (New)
35778	Blackout	Passenger - 1 Pc. / Color Box (New)

DOT & SAE **100%LED**

Technical Specification

Low Beam Application

1600 Lumens
2.1 Amps @ 12VDC

High Beam Application

2400 Lumens
2.25 Amps @ 12VDC





LED Fog Light For 2018-2021 Volvo VNR

- High quality injection molded polycarbonate lens
- Rugged die cast aluminum housing provides maximum protection from vibration and the elements
- Heavy duty plastic mounting base with OE spec mounting patterns
- Direct plug-n-play with OE style electrical terminal
- Easy replacement to original style fog light

32829 1 Pc. / Box



430 Stainless Steel Bug Deflector For Peterbilt 378/379 Short Hood And 357

- Highly polished 430 stainless steel
- Requires drilling holes in hood to install
- Hardware included for installation

29018 1 Pc. / Box



ABS Center Bumper Side Trim For 2018-2021 Volvo VNL

- Quality injection molded ABS plastic
- Feature original style mounting posts for easy installation
- Satin silver painted finish

42507 Driver - 1 Pc. / Box

42508 Passenger - 1 Pc. / Box



430 Stainless Steel Bug Deflector For Peterbilt 379 Long Hood

- Highly polished 430 stainless steel
- Requires drilling holes in hood to install
- Hardware included for installation

29019 1 Pc. / Box



Stainless Speed/Tachometer Dash Panel Trim For 2006+ Kenworth W900, T800, & C500

- Highly polished 304 stainless steel finish for durability and shine
- Pre-applied double sided tape on back for easy installation

21810 1 Pc. / Card



Chrome Center Dash Upper Panel For 2018-2021 Freightliner Cascadia

- Beautiful chrome plated finish with triple chrome plating process
- Quality injection molded plastic for durability
- Mounting clips pre-installed for easy installation
- Use of non-marking plastic pry tool is recommended, item #99135
- Dress up your truck with show winning shine!

42441 1 Pc. / Color Box



Chrome Plastic Blank Switch Covers For Kenworth T680, T880, W990

- Beautiful high quality chrome plated finish with triple chrome plating process
- Quality injection molded plastic for durability
- Double sided tape on back for easy installation
- Fits 2013-21 T680, 2013-21 T880, & 2019-21 W990

41453 2 Pc. / Card



Chrome Steering Wheel Hub & Horn Button Kit For 2014-2021 Kenworth T680 & Peterbilt 579

- Die-cast 36-spline steering hub with chrome plated plastic hub cover
- Beautiful chrome plated aluminum horn bezel and horn button
- Quality contact plate and wires to horn button
- Mounting hardware to horn bezel included
- Also fits 2014+ Kenworth T880, 2014+ Peterbilt 567, and 2014-2016 Peterbilt 587
- Design specifically for use with United Pacific 3-bolt steering wheels
- Warning: 2014+ Peterbilt & Kenworth equipped with steering angle sensor & stability control require special installation
- Consult installation instruction sheet to prevent vehicle damage
- Install instructions included and available online as digital download

88292 1 Pc. / Color Box

NEW ITEMS

December 2021

ULTRALIT PLUS LED PROJECTOR HEADLIGHT ASSEMBLY

ULTRALIT PLUS - Chrome Full LED Projector Headlight Assembly With SS Peterbilt 359 Style Housing

- Unique headlight design with double-row individual LED projectors and chrome inner design
- Pre-assembled with highly polished Peterbilt 359 style stainless steel rear housing
- 10 super bright high beam and low beam LEDs behind quality polycarbonate lens
- Chrome center divider bar with 15 amber LED turn signal and 15 white LED DRL
- Chrome plated molded plastic front bezel with screw-less clip-on design
- Energy efficient solid-state circuit board engineered for 12V DC systems
- Wiring to truck's headlight harness is required
- Mounts directly onto Peterbilt 359 headlight mounting arm
- Peterbilt 378, 379, 388, and 389 require separate mounting arm UP item #30438 (not included). Additional mounting hole on hood might be required
- Install note: adjust low and high beam aim before snapping front bezel in place
- DOT/SAE, FMVSS 108

35839	Chrome	Driver - 1 Pc. / Color Box
35840	Chrome	Passenger - 1 Pc. / Color Box
35865	Blackout	Driver - 1 Pc. / Color Box
35866	Blackout	Passenger - 1 Pc. / Color Box



DOT & SAE

304
STAINLESS

Technical Specification

Low Beam Application	High Beam Application
4000 Lumens	4000 Lumens
5 LEDs/2.5A	5 LEDs/2.5A
12V DC Input	12V DC Input

HEADLIGHT ADJUSTMENT

Low Beam Adjuster (Up and Down):
 Beam Down = (Clockwise A+B Simultaneously)
 Beam Up = (Counterclockwise A+B Simultaneously)

Low Beam Adjuster (Left and Right):
 Beam Left = (Clockwise A+Counterclockwise B)
 Beam Right = (Counterclockwise A+B Clockwise B)

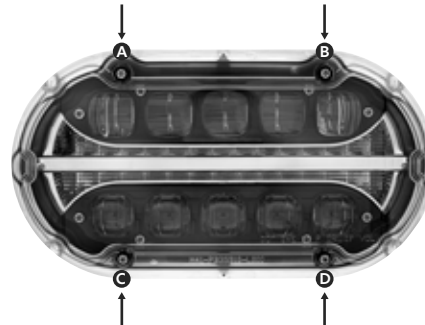

High Beam Adjuster (Up and Down):
 Beam Up = (Clockwise C+D Simultaneously)
 Beam Down = (Counterclockwise C+D Simultaneously)

High Beam Adjuster (Left and Right):
 Beam Left = (Clockwise C+Counterclockwise D)
 Beam Right = (Counterclockwise C+B Clockwise D)





Chrome 6 LED Headlight For Peterbilt 386 (2005-2015), 387 (1999-2010), 382 (2007-2018), & 384 (2007-2014)

- All LED 12 volt headlight assembly with 6 high power low and high beam LEDs
- Features 12 bright amber LEDs turn signal with sequential operation, and 2 side marker LEDs
- Unique position light bar design with 22 bright white LEDs
- Easy plug-in design, plugs into existing headlight wiring harness
- Low beam: 2000 Lumens, 2.0 Amps @ 12VDC
- High beam: 3000 Lumens, 3.0 Amps @ 12VDC
- DOT/SAE, FMVSS 108



DOT & SAE

100%LED

Technical Specification

Low Beam Application
2000 Lumens
2.0 Amps @ 12VDC

High Beam Application
3000 Lumens
3.0 Amps @ 12VDC

35761	Chrome	Driver - 1 Pc. / Color Box
35762	Chrome	Passenger - 1 Pc. / Color Box
35763	Blackout	Driver - 1 Pc. / Color Box
35764	Blackout	Passenger - 1 Pc. / Color Box



Hood Air Intake Grille With LED For 2018-2021 Freightliner Cascadia 126

- Made of quality plastic with original contour and mounting clips
- Feature 96 bright inward facing LEDs, unique glowing effect when on
- Extra long wiring, simply run it along the side of the hood
- Replaces OEM #A17-21068-000 (Driver) & A17-21068-001 (Passenger)

42863	Amber LED	Driver - 1 Pc. / Card
42864	Amber LED	Passenger - 1 Pc. / Card
42865	Blue LED	Driver - 1 Pc. / Card
42866	Blue LED	Passenger - 1 Pc. / Card
42867	Green LED	Driver - 1 Pc. / Card
42868	Green LED	Passenger - 1 Pc. / Card
42869	Red LED	Driver - 1 Pc. / Card
42870	Red LED	Passenger - 1 Pc. / Card
42871	White LED	Driver - 1 Pc. / Card
42872	White LED	Passenger - 1 Pc. / Card





430
STAINLESS

430 SS Door Window Shade/Wind Deflectors For Freightliner Cascadia

- Highly polished 430 stainless steel
- Includes brackets for passenger door mirror
- Easy mounting with 3M double sided tape
- Sold as a pair

29147	2018-2021	Pair / Box
29148	2008-2017	Pair / Box

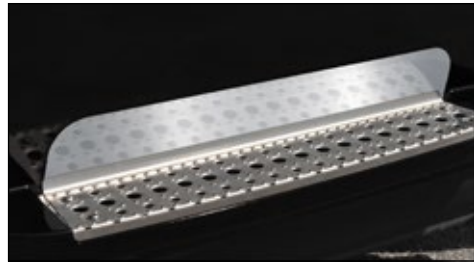
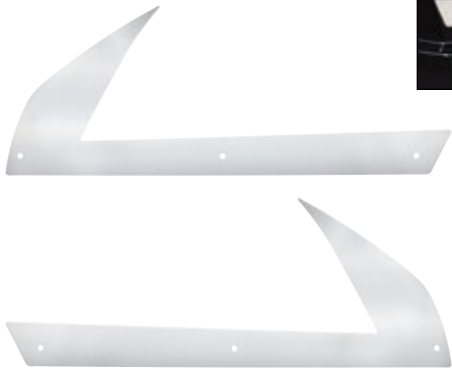

430
STAINLESS

430 SS Below Headlight Fender Guards For 2018-2021 Freightliner Cascadia

- Highly polished 430 stainless steel
- Provides protection against road debris
- Clean surface recommended for installation
- Easy mounting with 3M double sided tape
- Sold as a pair

29149	Pair / Box
--------------	------------

430
STAINLESS

430 SS Lower Step Surface Protective Plates For 2018-2021 Freightliner Cascadia

- Highly polished 430 stainless steel
- Protects paint from scratches and scuffs
- Clean surface recommended for installation
- Easy installation with 3M double sided tape
- Sold as a pair

29153	Pair / Box
--------------	------------



430
STAINLESS

430 SS Grille Surround With Hood Tilt Handle For 2018-2021 Freightliner Cascadia

- Highly polished 430 stainless steel
- Provides protection against road debris
- Enhanced additional protection with side grille deflectors
- Requires drilling holes in hood to install
- Features sturdy built in grab handle for hood tilting
- Hardware included for installation

29152

1 Pc. / Box



Chrome Headlight Bezel For 1996-2005 Freightliner Century - Competition Series

- Beautiful chrome plated injection molded plastic
- Easy installation to hood with original style mounting posts

32836

Driver - 1 Pc. / Box

32837

Passenger - 1 Pc. / Box



ExacFit
OE Style Engine Cooling Part

M1400 Type Fan Shroud For 2013-2018 Freightliner Cascadia 125

- Made of quality polypropylene reinforced with fiberglass
- 2-piece design with original contour and mounting holes
- OEM #A05-30850-000

42509

1 Pc. / Box

Terms & Conditions / Ordering Guidelines

New Accounts

Initial minimum buy-in is \$2,000 (or to be determined by United Pacific Industries, UPI hereafter). All initial orders must be prepaid in advance by Cashier's Check or VISA/MC. All new/potential accounts must complete a UPI "New Customer Info/Credit Form" and follow the Dealer Qualification Instructions. Upon completion of the credit application, approved accounts will be assigned payment terms of NET 30 Days (from invoice date). Accounts denied a credit line will be required to prepay in advance by Cashier's Check or VISA/MC.

Payment Terms

Term Accounts: Accounts with NET 30 Days terms are required to submit payment within the 30 days from the date of invoice. Acceptable forms of payment include checks, ACH (Automated Clearing House), or wire transfer.

A service charge of 1.5% per month will be imposed on invoices not paid within the 30 day term. Delinquent accounts will be required to pay Cash-In-Advance (CIA). Checks will be accepted but orders will not be released until the check is cleared by the bank. Past due invoices will delay current orders. Please check with UPI on your account status when placing an order.

Credit Cards

Accounts denied credit terms may pay by Visa or MasterCard. Credit card will be charged upon shipment. Credit card payments will not be accepted once an order has been shipped. UPI does not accept American Express or Discover card.

COD

A \$9.00 fee will be assessed per COD box for all FedEx/UPS COD shipments. Truck COD shipment fees are to be determined later by trucking company.

Returned Checks

A \$30 NSF (Non Sufficient Fund) fee will be assessed on each incidence a check is returned to UPI.

Ordering Guidelines

Placing Orders

New orders may be placed by any of the following methods

- Dealer Portal Dashboard: UPtruckparts.com/profile/login
- Email: returns@upauto.com
- Fax: (888) 986-5988

Telephone: In order to minimize errors, customers are encouraged to submit their orders by fax or mail. Telephone orders should be limited to smaller orders such as add-ons to orders already submitted and/or fill-ins occurring between larger restocking orders.

Changes to Orders

Initial minimum buy-in is \$2,000 (or to be determined by United Pacific Industries, UPI hereafter). All initial orders must be prepaid in advance by Cashier's Check or VISA/MC. All new/potential accounts must complete a UPI "New Customer Info/Credit Form" and follow the Dealer Qualification Instructions. Upon completion of the credit application, approved accounts will be assigned payment terms of NET 30 Days (from invoice date). Accounts denied a credit line will be required to prepay in advance by Cashier's Check or VISA/MC.

Cancelling Orders

Cancellation of orders must be submitted via fax or email within 24 hours of the order date. If the order has already shipped it will be the customers responsibility to return the order at the customers own expense. A restocking fee may apply, please see "Return" policy for further detail.

Backorders

Customers have the option of having their backorders shipped or cancelled. UPI will notify customer as to availability of backorders and will be able to ship any backorder items customer still needs as part of their next stock order. UPI reserves the right to cancel backorders that are 6 month or older from invoice date.

Minimum Orders

A minimum order of \$50.00 is required. Orders below \$50.00 will be assessed a minimum order fee of \$10.00.

Packaging

A 10% service charge will be added to orders with special packaging or UPC barcoding requirements.

Lead Times

Standard lead time for all United Pacific orders is 1-3 business days from the receipt of the purchase order. Larger orders may require a lead time of up to 5 business days. Transit time of 3-5 business days must be considered when placing orders. UPI cannot be responsible for delays in shipment after an order leaves our warehouse. UPI will work to resolve delays with freight forwarding firms, however, delays do arise from time to time due to weather and unforeseen circumstances beyond UPI's control. Express order are exempted; please view Freight/Shipping Policy for further detail.

Order Confirmation

United Pacific will acknowledge receipt of orders by email/fax/telephone within 1 business day of receipt. If confirmation is not received, please contact UPI to ensure your order was received.

Freight / Shipping Policy / Claims

Prepaid Freight

Stock orders between \$50 and \$1,299.99 (US Lower 48 States and Canada), \$50 and \$2799.99 (Alaska and Hawaii), [all price net US\$], will be shipped FOB Long Beach, California. Stock orders of \$1,300.00 (US Lower 48 States and Canada), \$2800.00 (Alaska and Hawaii), [based on UPI current pricing], or more will be shipped Freight Prepaid Ground to a single location only. Exclusions on prepaid: 1) Grille Guard (item# 80000) will always ship FOB Long Beach. 2) Express NDA and 2-day orders, Special Net Pricing orders, and Special Quote Pricing orders ship FOB Long Beach. United Pacific reserves the right to select the carrier of our choice. Customer may select the carrier of their choice at their own expense, negotiated rates and insurance. UP cannot be held responsible for shipping loss or damage if customer selects their own carrier. If customer elects to choose their own freight carrier, orders will be shipped via FREIGHT COLLECT:

Will Call Orders

Will Call orders can be picked up 2 - 4 hours after placing the order. Customers should always call ahead to confirm when order will be ready to pick up.

Shipping Policy

International Shipments

Shipments to locations outside the continental United States will be shipped to the customer's shipping agent or broker within the continental United States in accordance with the US freight policy. International customers will be responsible for the duties and taxes of their respective country.

Shipping Policy / Claims

Express Orders

All express orders, such as Next Day, Second Day, 3 Day Service & Will Call, must be faxed/emailed. Order confirmation will be faxed to the customer for final approval. If confirmation is not received, please contact UPI to ensure your order was received. Customers are required to sign off on express orders and fax confirmation back to UPI. Cut off for express order is 12:00PM. Express orders received after 12:00PM may or may not ship the same day. Please call UPI to confirm projected shipping date or will call time. Due to the high cost of express shipments, customer may request UPI to call to confirm freight charges. If customer does not request confirmation, UPI will ship the express order.

Drop Shipments

All drop shipment orders will be assessed a 5% processing fee. Drop shipment processing fee will be automatically added to the invoice without notice. All drop shipment orders must be faxed in. No freight allowance or prepaid freight will be permitted for any drop shipments, thus, all drop ship orders, regardless of order size, are FOB Long Beach, CA.

Claims

General Policy

All claims (Shortage, Mis-Shipped, Damage, Overage, Customer Error & Billing Error) must be submitted to UPI within 3 business days of the receipt of shipment. Claims submitted beyond 3 business days of the receipt of shipment will be voided by UPI. On all shipments, the person who signs and receives the shipment is responsible for noting on the Bill of Lading, in writing, whether any boxes arrived damaged or shorted. Failure to do so will void all claim rights between all parties. UPI will have no recourse against the trucking company if customer does not note any damages or shortages on the Bill of Lading. The customers receiving department must count and sign for the exact number of boxes received. Failure to follow the above instructions will void all claim rights between all parties.

Shortages / Mis-Ships / Damages

While UPI strives to fill every order with 100% accuracy, on occasion an item may get shipped in error or get damaged during shipping. In the event this occurs, please follow the process below. Note: This type of claim must be reported to UPI within three (3) business days of receiving the order.

- Email: returns@upauto.com
- Fax: (888) 986-5988

Note: To ensure you receive a timely credit, we cannot accept claim requests by phone.

2. You will be required to provide the following information:
 - Your business name
 - Contact name and telephone number (in case we have questions)
 - Date the order was received
 - A copy of the Packing List / Invoice noting the item number and quantity that was shipped in error or damaged during shipping.
 - Special instructions you have for us.
3. UPI will send a return label so you can ship the items back.
4. Once we receive the miss-shipped/damaged item(s) a credit will be issued to your account on the next billing cycle.

Claims / Warranty

5. Shortages will be credit to the Customers' account, unless customer would like the shortages replaced.

Overages

UPI strives to provide our customers with the best customer service and products, in turn we would greatly appreciate any help from customer in notifying UPI of any shipping overages. Customers will be offered the option of retaining the merchandise or returning the merchandise to UPI at UPI's expense. If the items are to be returned, an RMA number and return shipping label will be provided.

Customer Errors

Any item or quantity ordered in error by the customer may be returned by contacting UPI for a RMA number.

1. To make it easy for you we have two acceptable methods for requesting the RMA:
 - Email: returns@upauto.com
 - Fax : (888) 986-5988

Note: To ensure you receive a timely credit, we cannot accept claim requests by phone.

2. You will be required to provide the following information.
 - Your business name
 - Contact name and telephone number (in case we have questions)
 - A list of the items number and quantity ordered in error
 - Special instructions you have for us
3. UPI will review the request to ensure the products are within the return period.
4. Once we have validated the request, United Pacific will issue an RMA number to the customer. In issuing the RMA approval, the following conditions will apply:
 - Returned items are subject to a 20% re-stocking fee.
 - Return shipping costs are the responsibility of the customer.
 - Items must not have any retail/price sticker on exterior packaging or they will be returned to the customer at customer's expense and no credit given.
 - Items must be in good condition with original packaging intact or they will be returned to the customer at customer's expense and no credit given.
 - Allow up to 30 days for the credit to be issued from the time the returned items are received.

Billing Errors

Billing errors should be reported to UPI within 3 business days of invoice receipt. Customers are asked to provide the invoice number, part number, and quantities in question. Once verified, UPI will issue a credit or an invoice for the difference in billing error. provided.

Warranty

General Policy

UPI offers a NO HASSLE WARRANTY RETURN policy. Warranty claims can only be submitted through an authorized UPI Distributor. UPI warranty is not transferable and applies to the original installation and purchase only. UPI warranty varies by product and each item's warranty period is stated on UPI's product web page. In no event shall UPI be liable for incidental or consequential damages, nor shall UPI be liable for any claims or damages arising out of or connected with the UPI warranty which exceed the purchase price of the products.

There are no warranties, expressed or implied (including any warranty of merchantability or fitness) that extend beyond this warranty. The warranty does not apply to costs associated with the loss of use of the product, loss of time, inconvenience, commercial loss, incidental or consequential damages. The warranty does not apply to products which are damaged or made defective by faulty or incorrect installation. UPI reserves the right to alter the designs of products without assuming any obligation to modify previously manufactured products and will only replace warrantied products with redesigned products.

Warranty does not apply to merchandise that has been drilled, cut, welded, modified in any way or installed contrary to normal installation and usage.. In addition, UPI cannot be held liable for damages caused by road hazards, accidents, misuse, neglect, water intrusion, abuse or corrosive environments including acid washes and highway snow/ice chemicals which can cause discoloration and corrosion in aluminum, chrome, stainless steel and light products. UPI reserves the right to credit returned merchandise at the initial purchase price or at the current selling price, which price ever is lower.

Aluminum / Chrome / Stainless Steel Products

Aluminum, chrome, and stainless steel products carry either a limited 6 month warranty, or a limited 1 year warranty (from invoice date) against defects in material or workmanship. Check the product page on our website for specific warranty period.

All Grill Guards (Item # 80000): A) Stainless Steel Materials and factory workmanship of the product itself carry a Limited Lifetime warranty. B) The Stainless steel polish and finish has a 12 month warranty. C) This warranty is provided only to the original purchaser/ consumer, and on the original installation. Warranty is not transferable. Product failure or breakage due to accident/wreck or improper installation is not covered.

All mounting kits (Item # 80001, 80002, 80003, 80004, 80005): A) Steel Materials and factory workmanship on the sub-assembly bracket are Lifetime warranty. B) The painted or zinc finish has a 12 month warranty. C) Any ancillary components and parts (e.g. washers, bolts, spacers, etc.) which are not part of the sub-assembly, carry a 12 month warranty. D) This Warranty is provided only to the original

Warranty / Returns

purchaser/consumer, and on the original installation. Warranty is not transferable. Product failure or breakage due to accident/wreck or improper installation is not covered.

Lighting Products

Incandescent Lighting:

All incandescent lighting products carry a limited 12 month warranty (from invoice date) against defects in material or workmanship. The limited 12 month warranty does not apply to several applications, such as, buses, construction equipment, and off road vehicles.

LED Lighting:

All LED lighting products carry a specific Limited Warranty (from invoice date) against defects in material or workmanship.

- LED with vehicle specific application is limited lifetime warranty to an original purchaser with receipt Examples of lifetime warranty product: CTL5720LED CTL5720LED for 1957 Chevy, FTL3201LED-L for 1932 Ford.
- LED Marker, 2", 2-1/2", 4", 7", Oval & Square Lights - Varies from 2 years to 10 years to Limited Lifetime, depending on specific item. The housing, bezel or mounting base on any light made from Chrome/Stainless carries a 6 month limited warranty.
- LED Cab Lights and Kits, Double/Single Stud Turn Signal and PB/ KW/FL/VL or non-make Turn Signals and any/all Strip Lights - Varies from 2 years to 10 years to Limited Lifetime, depending on specific item. The housing, bezel or mounting base on any light made from Chrome/Stainless carries a 6 month limited warranty.
- LED Beacon, Driving, Headlights, Work & Warning Lights - Varies from 6 months to 3 years. The housing, bezel or mounting base on any light made from Chrome/Stainless carries a 6 month limited warranty.
- All LED Accessory Lights (Honda, Stainless Steel Double/Single face Lights, Interior Lights, License Plate Lights, and any Accent Lights. The housing, bezel or mounting base on any light made from Chrome/Stainless carries a 6 month limited warranty.
- For any product that contains any type of light or LED, whether it is a stand alone light or LED, or part of a larger assembled item (e.g., Rear light panel), modifying electrical wiring, sockets, lighting pigtails and any electrical connection from the original configuration will void the warranty of both wiring, pigtail and the light or LED unit and cannot be warranted.

Returns

General Policy

All returns must be authorized by UPI. All return requests must be faxed or e-mailed (returns@upauto.com). A RMA number (Return Merchandise Authorization Number) will be provided. Returns not possessing a valid RMA number are subject to rejection and will be returned to sender at the dealer's expense.

All dealers are encouraged to use the Warranty RMA Claim Form and Dealer Portal Dashboard.

Defective Goods / Warranty Return

UPI offers our dealers a No Hassle Warranty Return. Please follow the instructions below for requesting a RMA for defective goods:

1. If any warranty issues occur, simply contact the UPI for RMA number. To make it easy for you we have three acceptable methods for requesting the RMA.

- Dealer Portal Dashboard: UPtruckparts.com/profile/login
- Email: returns@upauto.com
- Fax: 888-986-5988

Note: To ensure you receive a timely RMA credit, we cannot accept RMA requests by phone.

2. You will be required to provide the following information:
 - Your business name
 - Contact name and telephone number (in case we have questions)
 - A list of the defective item number and quantity with the nature/reason of the defect
 - Special instructions you have for us
 - The enclosed fax form may be used for your convenience to request an RMA
3. UPI will review the request to ensure the products are within the stated warranty period.
4. Once we have validated the warranty items, a RMA confirmation, listing the items and cost will be faxed to the dealer within 3 business days. UPI will process the credit to your account within 30 days.

Note: The majority of time there will be no need to return the warranty product to us.

However, from time to time, UPI may require some warranty products to be shipped back so we may analyze the cause of the failure. All warranty products that are required to be shipped back will be freight prepaid by UPI.

Stock Return

United Pacific Industries encourages all dealers to regularly monitor the sales volume and stock level of their inventory items. As sales trends may slow the movement of specific items, our hope is that those items are featured as "close-out specials" as to minimize stock

returns. We also understand that the dealer, from time to time, may accumulate over-stock items and desire to return those. Therefore, we have adopted the following policy below.

NOTE:

Items must have been purchased by the dealer requesting the stock return.
Items must have been purchased within the preceding 12 months.
Items that have been discontinued will not be considered for return.

1. Contact the United Pacific for RMA number.

We have 3 acceptable methods for requesting the RMA:

- Dealer Portal Dashboard: UPtruckparts.com/profile/login
- Email: returns@upauto.com
- Fax: 888-986-5988

Note: To ensure you receive a timely RMA credit, we cannot accept RMA requests by phone.

2. You will be required to provide the following information:

- Your business name.
- Contact name and telephone number (in case we have questions).
- A list of the defective item number and quantity with the nature/reason of the defect.
- Special instructions you have for us.

3. Your claim will be reviewed within 5 business days and you will be contacted by your sales representative who will discuss solutions to liquidate these slow moving items.

4. In the event United Pacific and the dealer agree to a credit in lieu of returning the items, this credit will be issued within 10 business days.

5. In the event items are returned by the dealer, United Pacific will issue an RMA number to the dealer. Once the RMA is issued, the following conditions will apply:

- Returned items are subject to a 20% re-stocking fee.
- Return shipping costs are the responsibility of the dealer.
- Items must not have any retail/price sticker on exterior package/box/card or they will be returned to the dealer at dealer's expense and no credit given.
- Items must be in good condition with original packaging intact, unblemished and in re-sellable condition, or they will be returned to the dealer at dealer's expense and no credit given.
- Allow up to 30 days for the credit to be issued from the time the returned items are received.

6. Stock returns may be requested throughout the year and are subject to final approval by United Pacific.

Closeout / Discontinue

UPI will not warranty or accept returns on Closeout/Discontinue items.

Procedure:

An inventory of the merchandise being returned must accompany each return.
The RMA number should be prominently displayed on each carton/box.

All Returns must be returned freight prepaid.

Ship Returns to:

United Pacific Industries
Attn: Returns Department
3788 E. Conant St.
Long Beach, CA 90808

RMA:

Outstanding RMA's will be automatically canceled if not used within 30 days of issuance.
Go to the Dealer Portal Guide Page for more information on RMA procedure.

Disclaimer

United Pacific Industries reserves the right to amend or update our Policies & Procedures without notice.

United Pacific Industries is not responsible for typographical, product information or print errors. Specifications on this catalog may be changed without advance notice. Products may look different from those in the photos on this catalog due to printing quality.



United Pacific

3788 E. CONANT STREET
 LONG BEACH, CA 90808
 TEL: (562) 421-3888
 FAX: (888) 986-5988
 TOLL FREE: (800) 790-6988
 UPauto.com

DEFECTIVE GOODS / WARRANTY CLAIM FORM

Date: _____
 Company Name: _____
 Address: _____
 City, State, Zip: _____
 Contact Name: _____
 Phone Number: _____
 Fax Number: _____
 Email: _____

List defective items below:

Item#	Qty	Description	Reason for Defect	Date Sold to Customer

Any special notes / instructions for United Pacific (list here):

File your claim at:
 by email - sales@upauto.com
 by fax - (888) 986-5988

Internal Use Only	
Date Received: _____	Final RMA: _____
RMA Approval Date: _____	Credit Amount: _____
RMA Number: _____	Approved by: _____

CALIFORNIA PROPOSITION 65 WARNING



WARNING: Cancer & Reproductive Harm-
www.P65Warnings.ca.gov

PRODUCT INDEX

ITEM#	PAGE#	ITEM#	PAGE#	ITEM#	PAGE#	ITEM#	PAGE#	ITEM#	PAGE#
10007	19	32814	25	36820	22	60054	25	20847M5	41
10013	15	32898	32	38922	40	60055	25	22941B	28
10045	33	32899	32	39161	30	60056	25	22942B	28
10046	33	34131	24	39162	30	70106	18	22943B	28
10047	31	34131	37	39163	30	70369	7	36515B	15
10049	26	34132	24	39164	30	70612	9	36743B	30
10057	42	34132	37	39165	30	70613	9	36744B	30
10059	26	34133	24	39212	40	70788	15	36745B	30
10060	19	34133	37	39565	36	70789	15	38170CB	22
10064	26	34134	24	39566	36	70790	15	38171CB	22
10070	42	34134	37	39909	12	70791	15	38362CB	22
10084	33	34135	37	40946	29	70792	27	38363CB	22
10117	38	34136	37	40970	43	70793	27	38922B	40
10326	20	34137	37	40971	43	70794	27	39311B	6
10337	5	34138	37	41069	43	70795	27	39312B	6
10341	8	35765	32	41451	44	70796	27	39313B	6
10342	5	35766	32	41452	35	70797	27	70601B	35
10342	8	35767	32	41775	4	72003	39	70622B	35
10347	38	35768	32	41776	4	72046	7	70644B	35
10348	33	35769	21	41777	4	72047	7	70645B	35
10348	38	35770	21	41778	4	72053	30	A1060-4	39
10569	13	35771	21	41779	4	72053	39	UCSW01	14
10570	13	35772	21	41780	4	80000	10	UF1219	14
10588	9	35773	21	41781	4	80001	10		
10770	27	35774	21	41782	4	80002	10		
10780	43	35775	13	41783	4	80003	10		
11016	27	35776	13	41784	4	80004	10		
11017	27	35779	11	41785	4	80005	10		
11018	27	35780	11	41786	4	90023	44		
11019	27	35781	11	42309	35	90066	44		
20531	31	35782	11	42439	9	90089	44		
21149	42	35819	3	42445	12	95002	20		
21150	42	35820	3	42446	12	98989	29		
21335	11	35821	3	42447	12	98990	23		
21821	39	35822	3	42486	9	98991	23		
21822	34	35823	3	42487	9	98992	23		
21943	34	35824	3	42489	25	98993	29		
21944	34	35825	3	42490	25	99018	23		
21945	41	35826	3	42491	25	99036	17		
21946	41	35829	7	42492	25	99060	23		
21947	41	35830	7	42493	25	99074	36		
21948	41	36002	6	42494	25	99086	29		
21949	41	36003	6	42495	25	99193	12		
21950	41	36446	19	42496	25	99194	12		
23496	14	36447	19	42825	31	99195	12		
23497	14	36448	19	42826	31	99196	17		
23498	14	36452	14	42844	38	99198	19		
23499	14	36454	5	42845	38	99199	16		
23766	28	36455	5	42846	38	99200	16		
23767	28	36456	5	42847	38	99201	17		
23768	28	36457	5	42848	31	99206	44		
23769	28	36515	15	42849	31	110861	9		
23770	28	36560	22	42851	34	110862	9		
23771	28	36561	22	42852	34	110863	12		
23772	28	36562	22	42853	34	110864	12		
23773	28	36563	22	42854	34	10000CB	11		
23774	28	36747	13	42855	39	10553CB	7		
30419	25	36748	13	46126	44	10554CB	5		
30614	35	36815	24	46174	39	10562CB	8		
31050	22	36816	24	48156	35	10564CB	4		
32598	32	36817	24	48157	35	10583CB	8		
32599	32	36818	24	52009	36	10778CB	4		
32813	25	36819	22	52010	36	10781CB	8		





United Pacific

UPauto.com | T 800.790.6988 | F 888.986.5988

© 2022 United Pacific Industries. All Rights Reserved. Products not shown to scale. Specifications subject to change without notice.

UF1221

2021 Truck New Product Collection



710270063505